

PU Adhesive

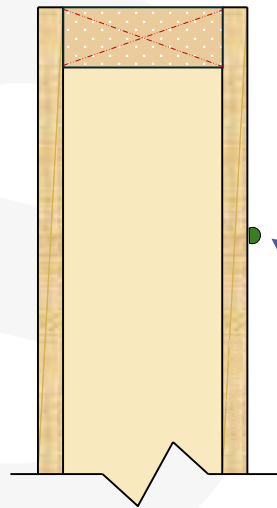

STEP 1

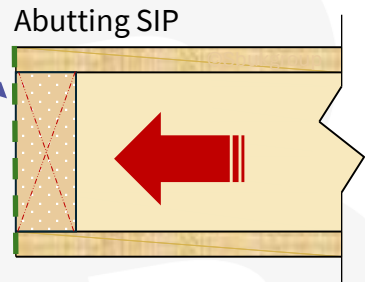

Bead of Silicon
(4mm continuous bead).

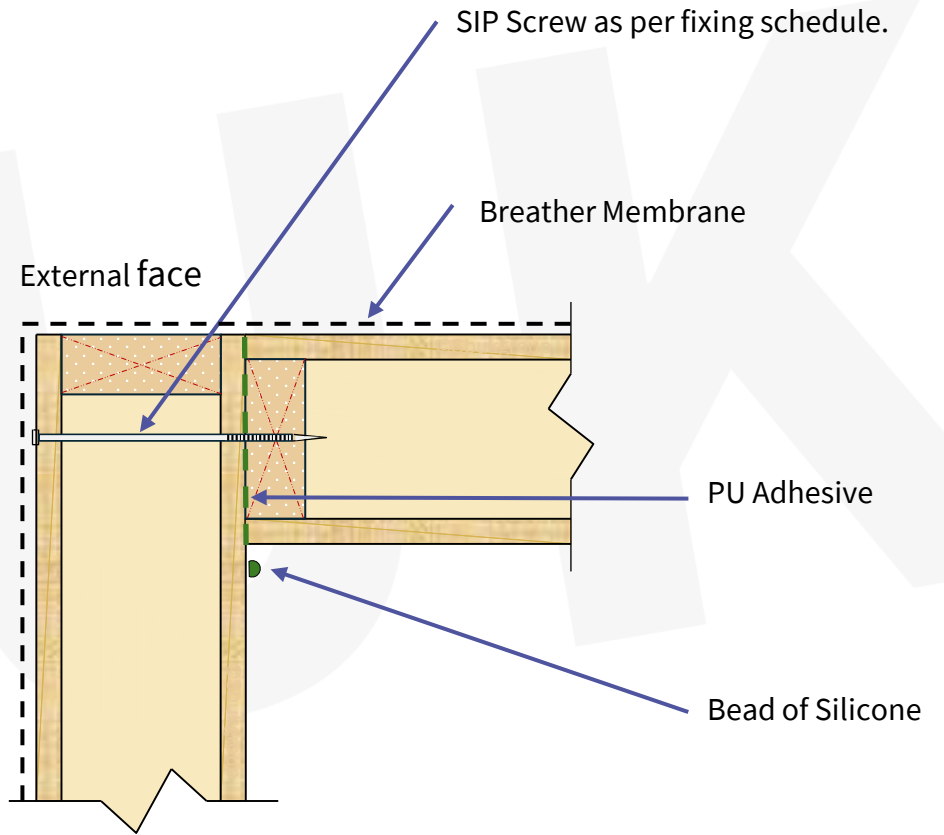

STEP 2

ALL CAPPING TIMBERS FIXED INTO REBATES AS PER DETAIL **SD-01**

*Details should be considered indicative only. Intellectual Property of SBUK.

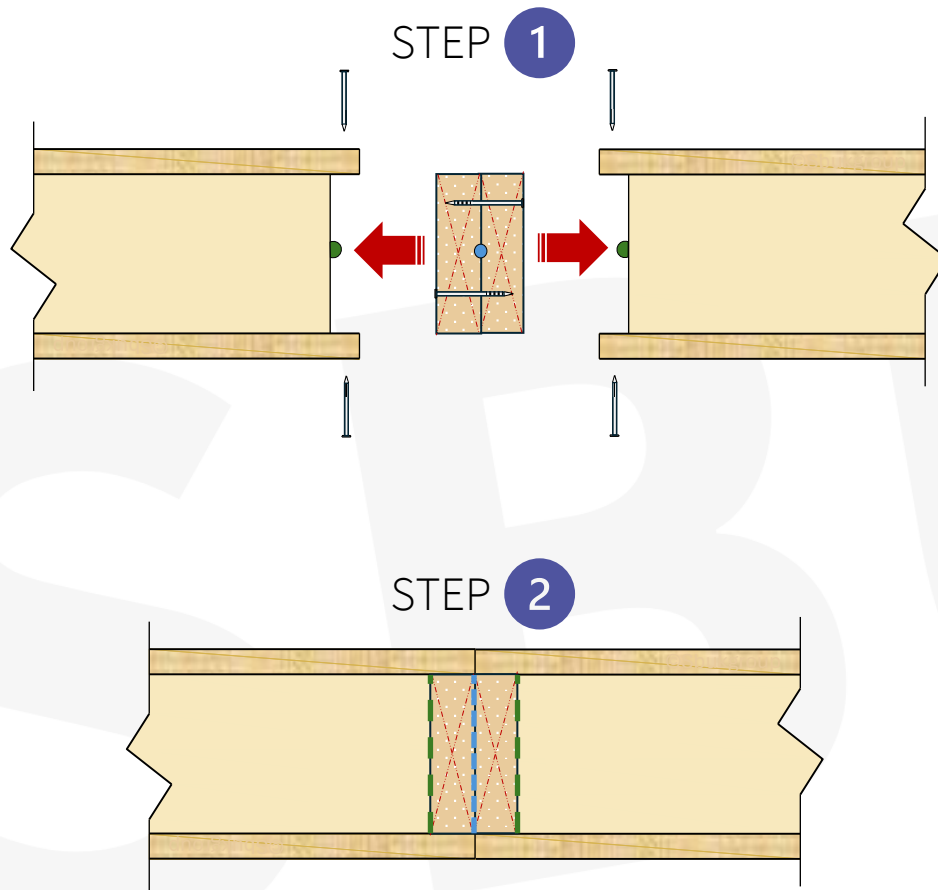

Timber joints to be either:

1 No. Solid Timber

or;

2 No. Timbers (nailed and glued).

When fully nailing Timbers, Glue is also to be used.

NO EXCEPTIONS

Solid Timber



2 no Rebate Timbers

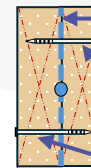

← Bead of PU Adhesive along one timber face prior to abutment.

← Nails as per fixing schedule.

***ALL SIPs REBATES PREPARED AS PER DETAIL**

SD-01

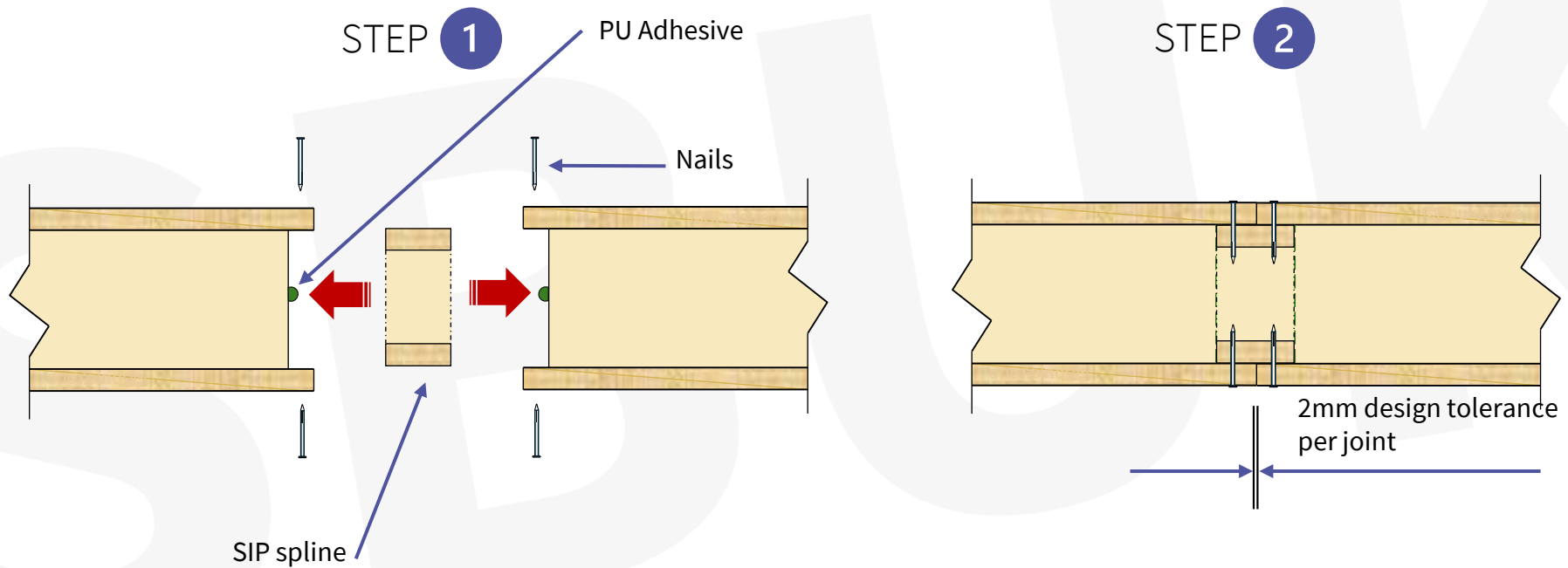

*ALL SIPs REBATES PREPARED AS PER DETAIL

SD-01

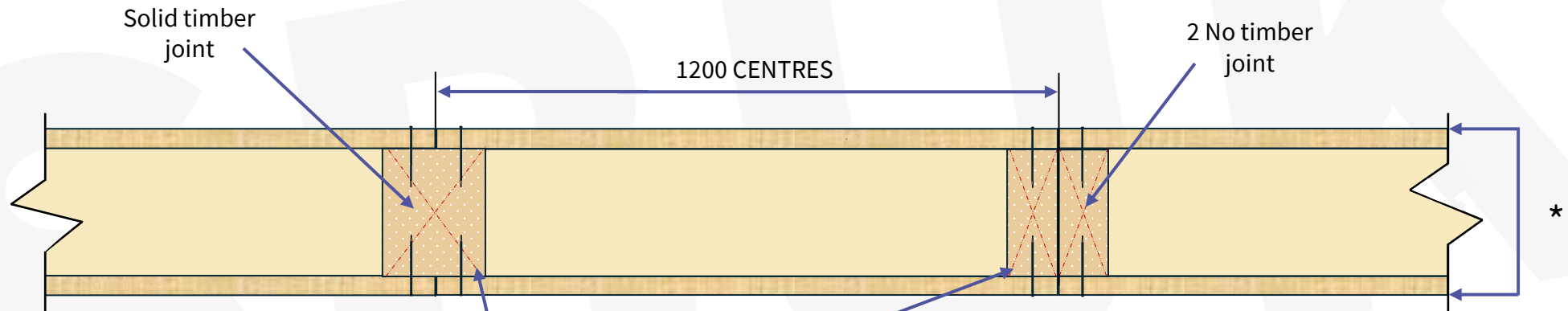

Timber joints to be either:
1 No. Solid Timber
or;
2 No. Timbers (nailed and glued).
When fully nailing Timbers, Glue is also to be used.
NO EXCEPTIONS

*SIP size

100, 125, 142, 150, 172, 175, 200, 225 mm

*Details should be considered indicative only. Intellectual Property of SBUK.

AS PER STA GUIDANCE SIPS SPRINGING LEVEL MIN 150MM ABOVE EXTERNAL GROUND LEVEL.

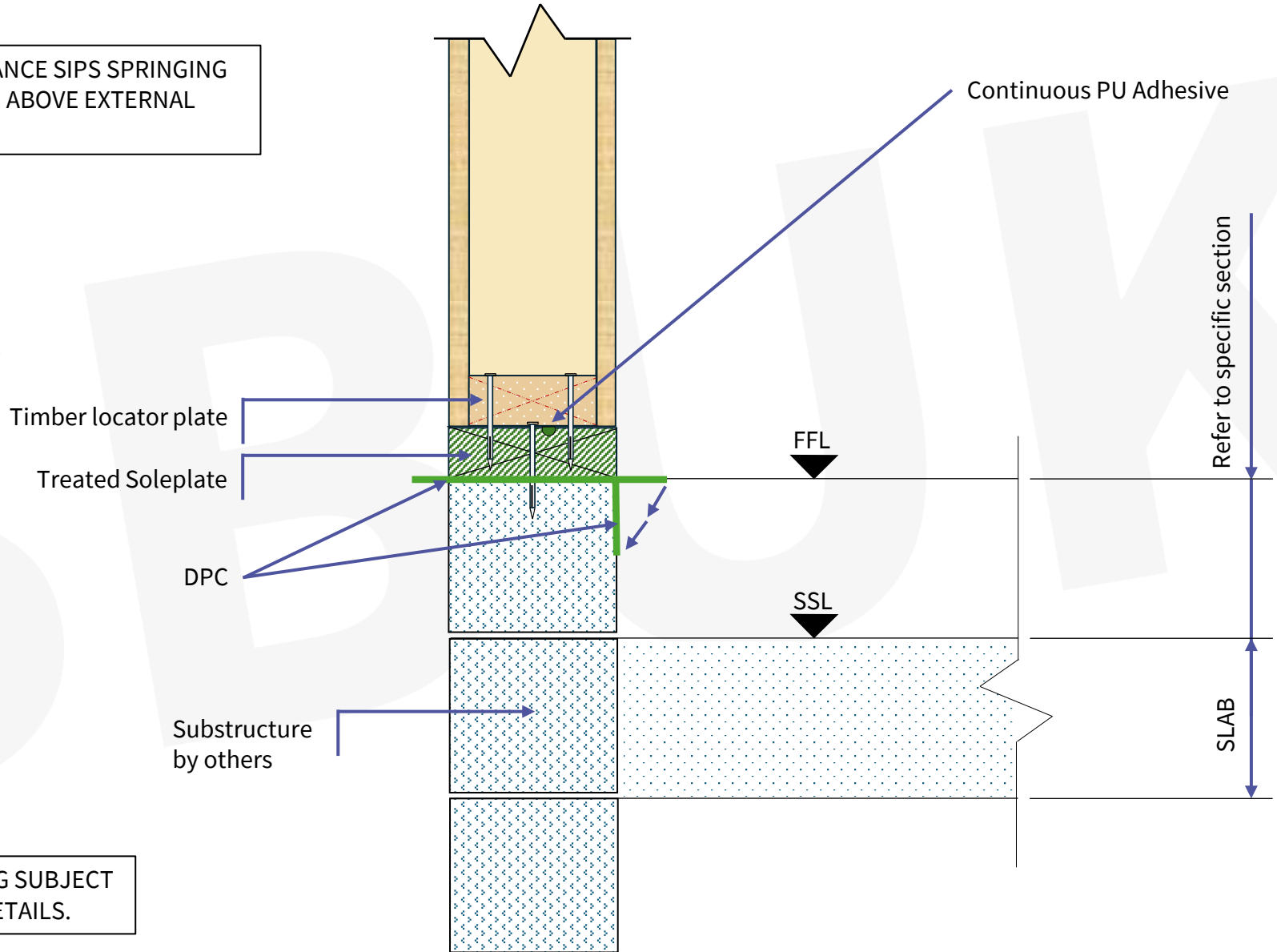

DPC POSITIONING SUBJECT TO CLIENT DETAILS.

*Details should be considered indicative only. Intellectual Property of SBUK.

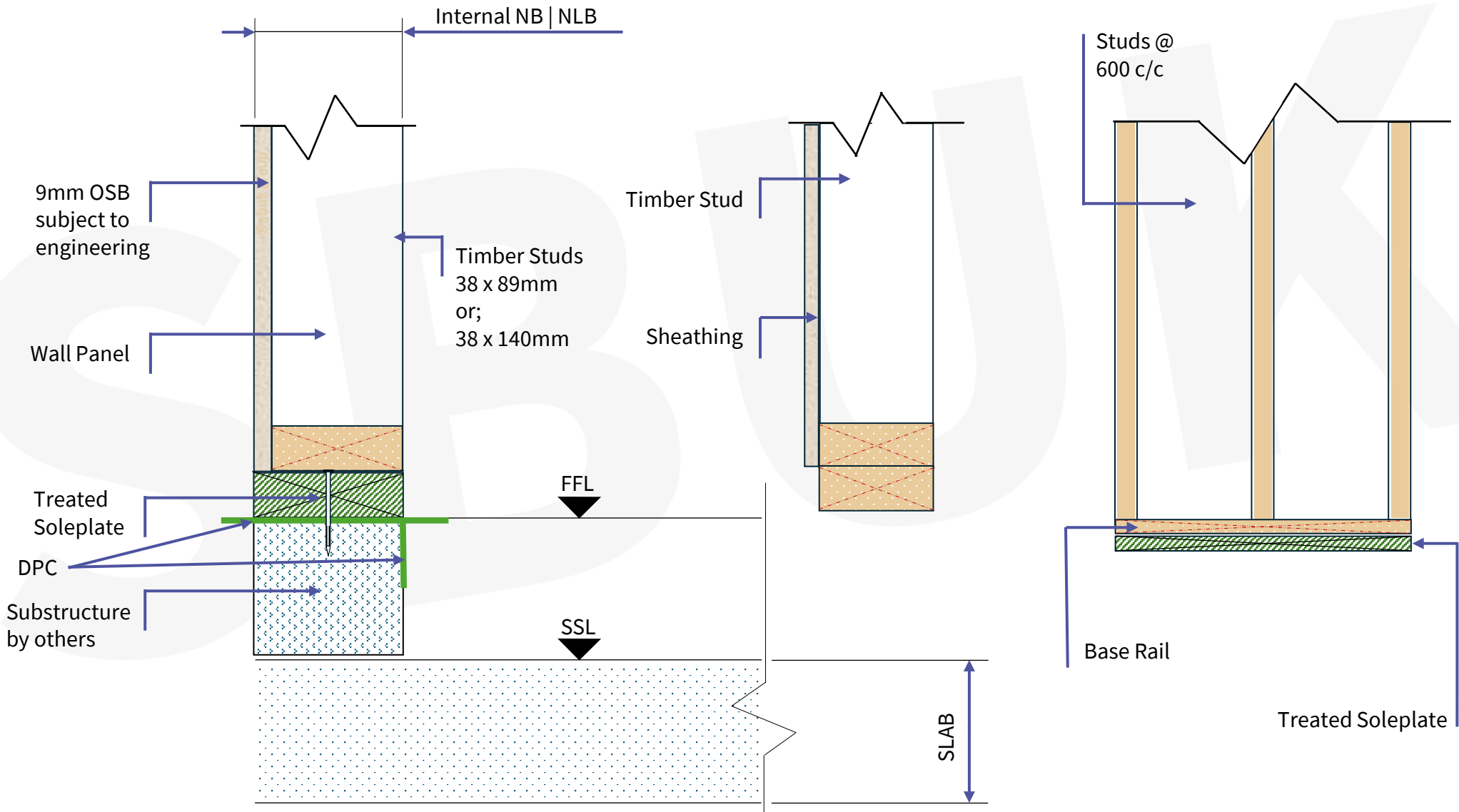

*Details should be considered indicative only. Intellectual Property of SBUK.

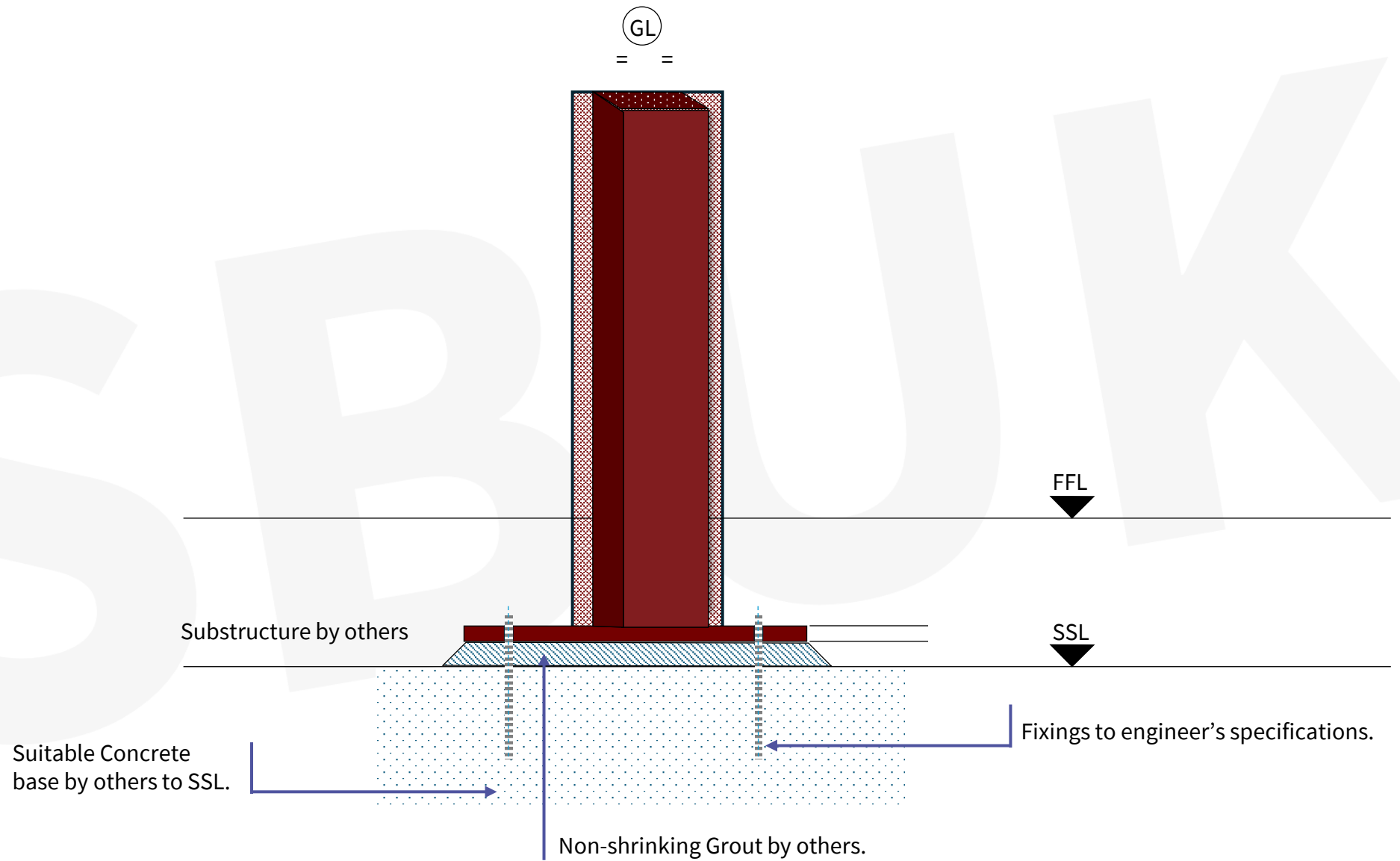

*Details should be considered indicative only. Intellectual Property of SBUK.

PLAN VIEW

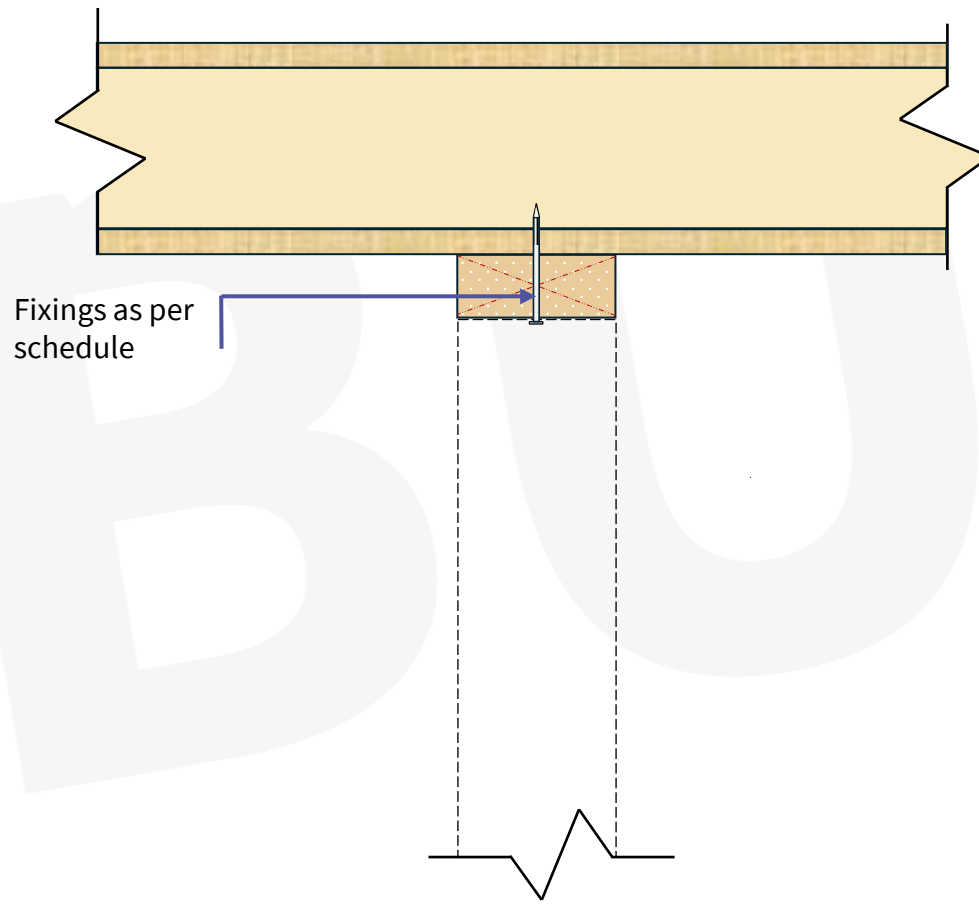

*Details should be considered indicative only. Intellectual Property of SBUK.

PLAN VIEW

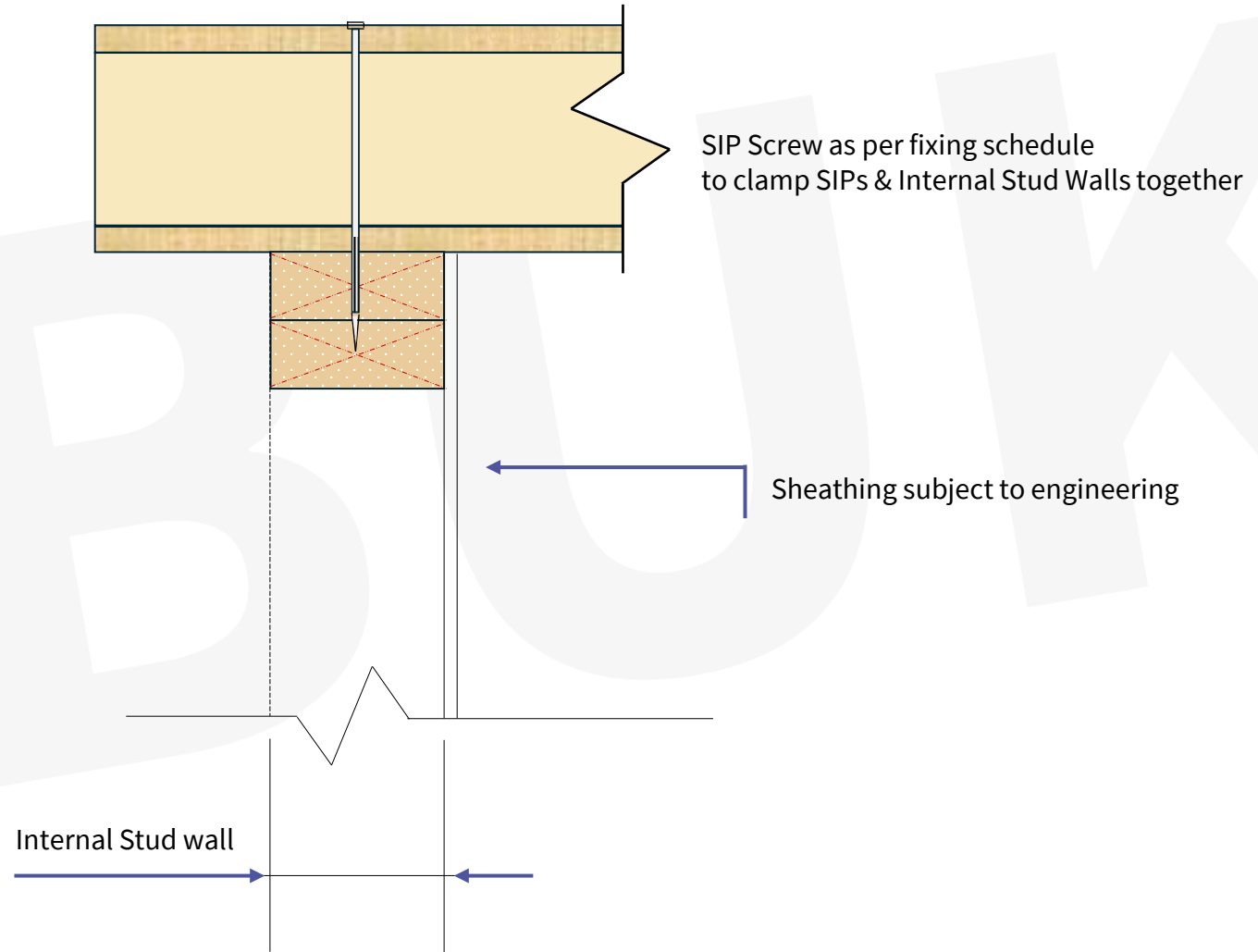

*Details should be considered indicative only. Intellectual Property of SBUK.

Internal Walls
PLAN VIEW

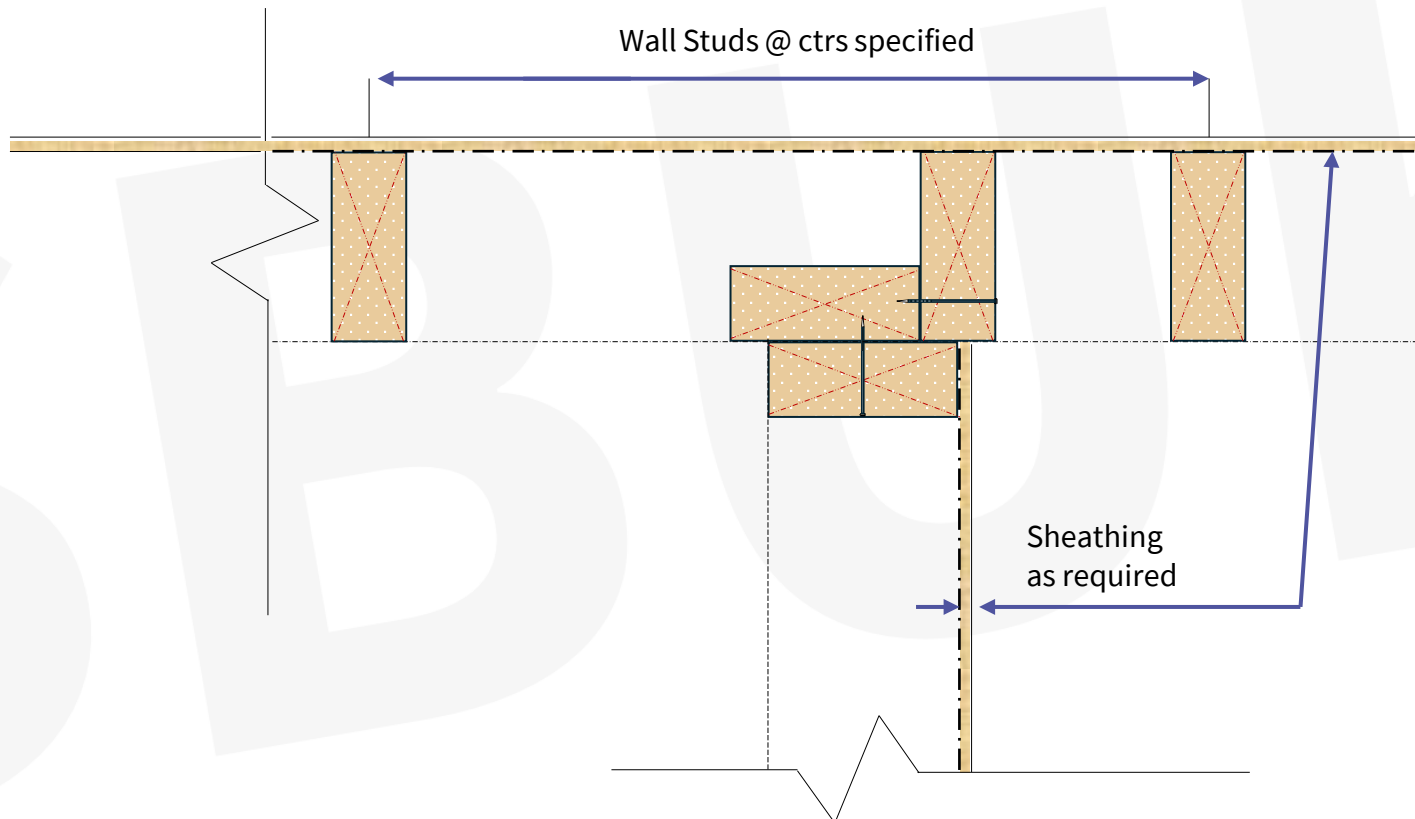

*Details should be considered indicative only. Intellectual Property of SBUK.

PLAN VIEW

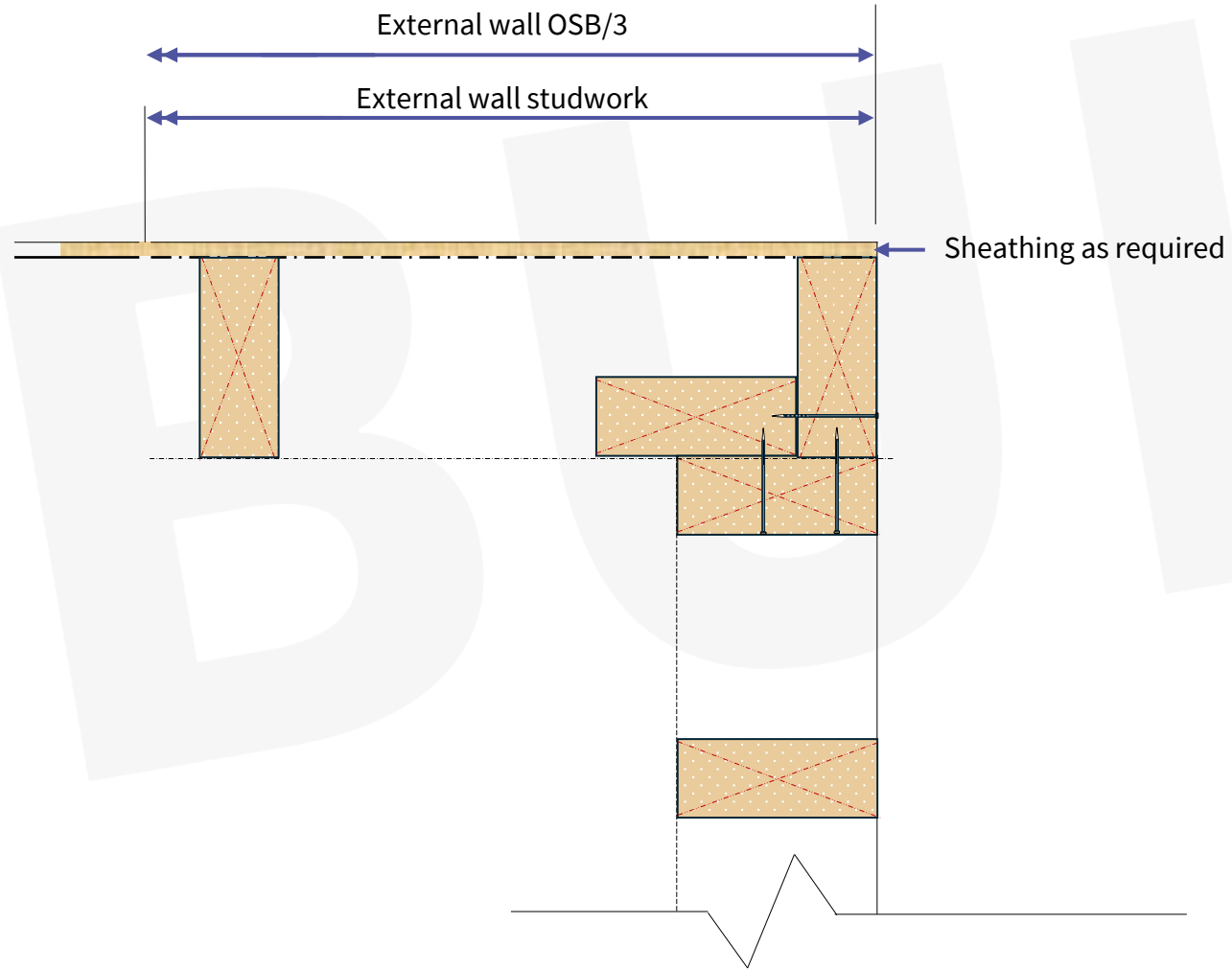

*Details should be considered indicative only. Intellectual Property of SBUK.

PLAN VIEW

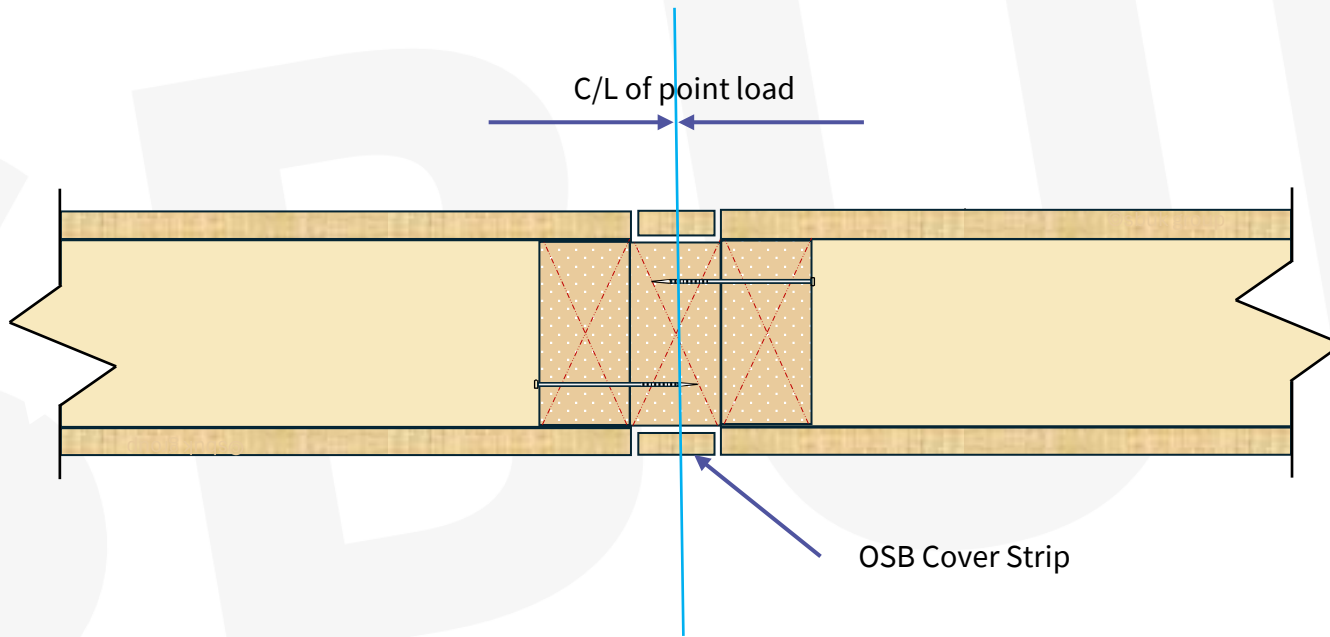

*Details should be considered indicative only. Intellectual Property of SBUK.

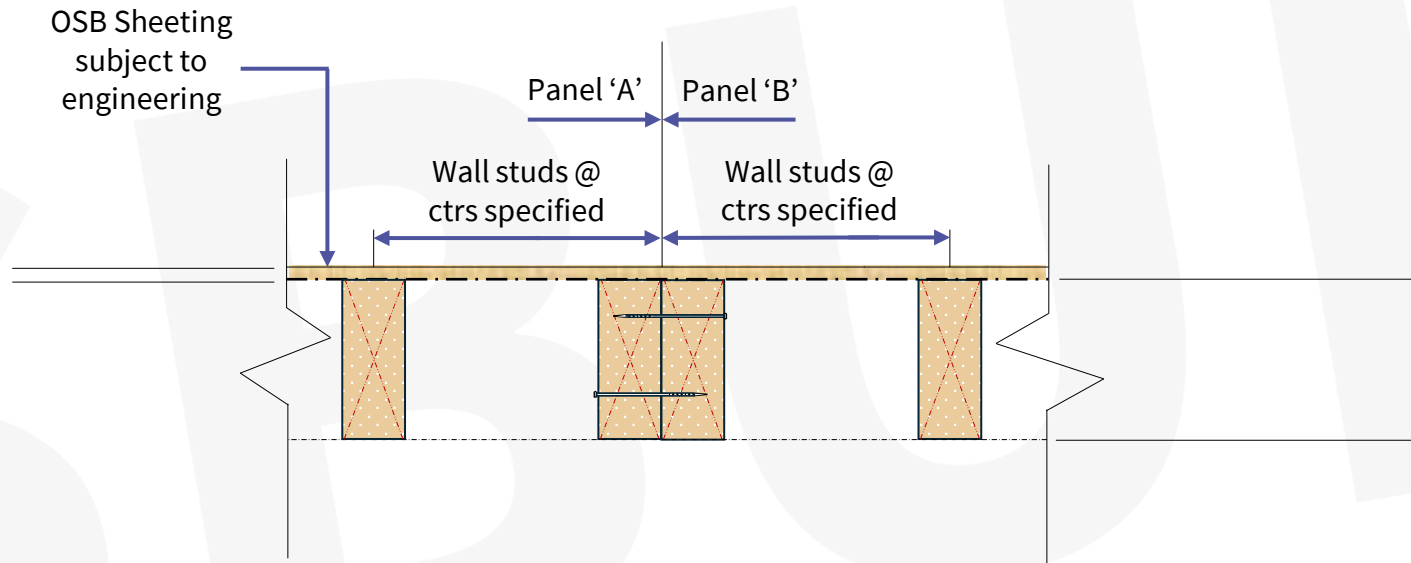

*Details should be considered indicative only. Intellectual Property of SBUK.

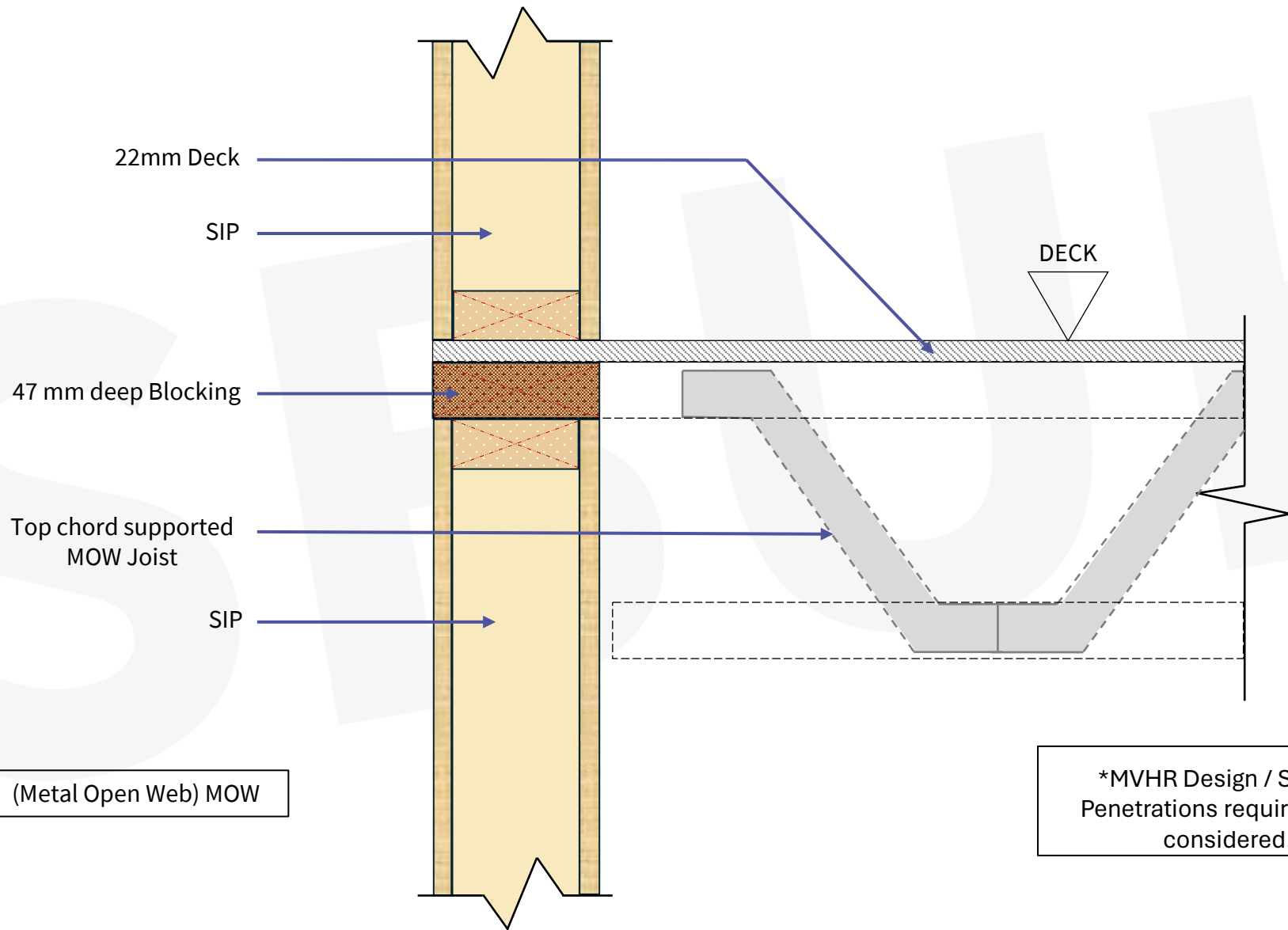

*Details should be considered indicative only. Intellectual Property of SBUK.

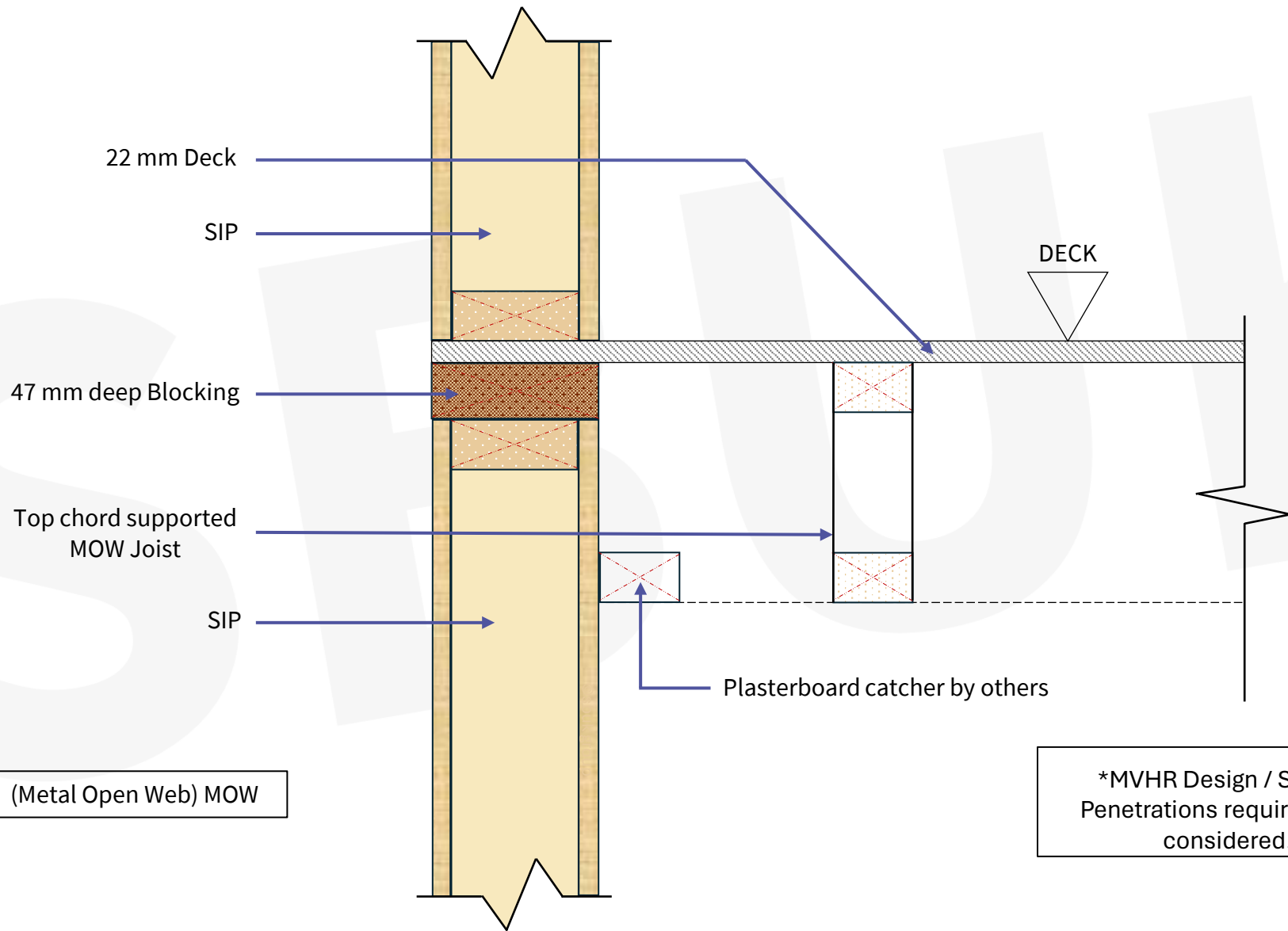

(Metal Open Web) MOW

*MVHR Design / Service Penetrations required to be considered.

*Details should be considered indicative only. Intellectual Property of SBUK.

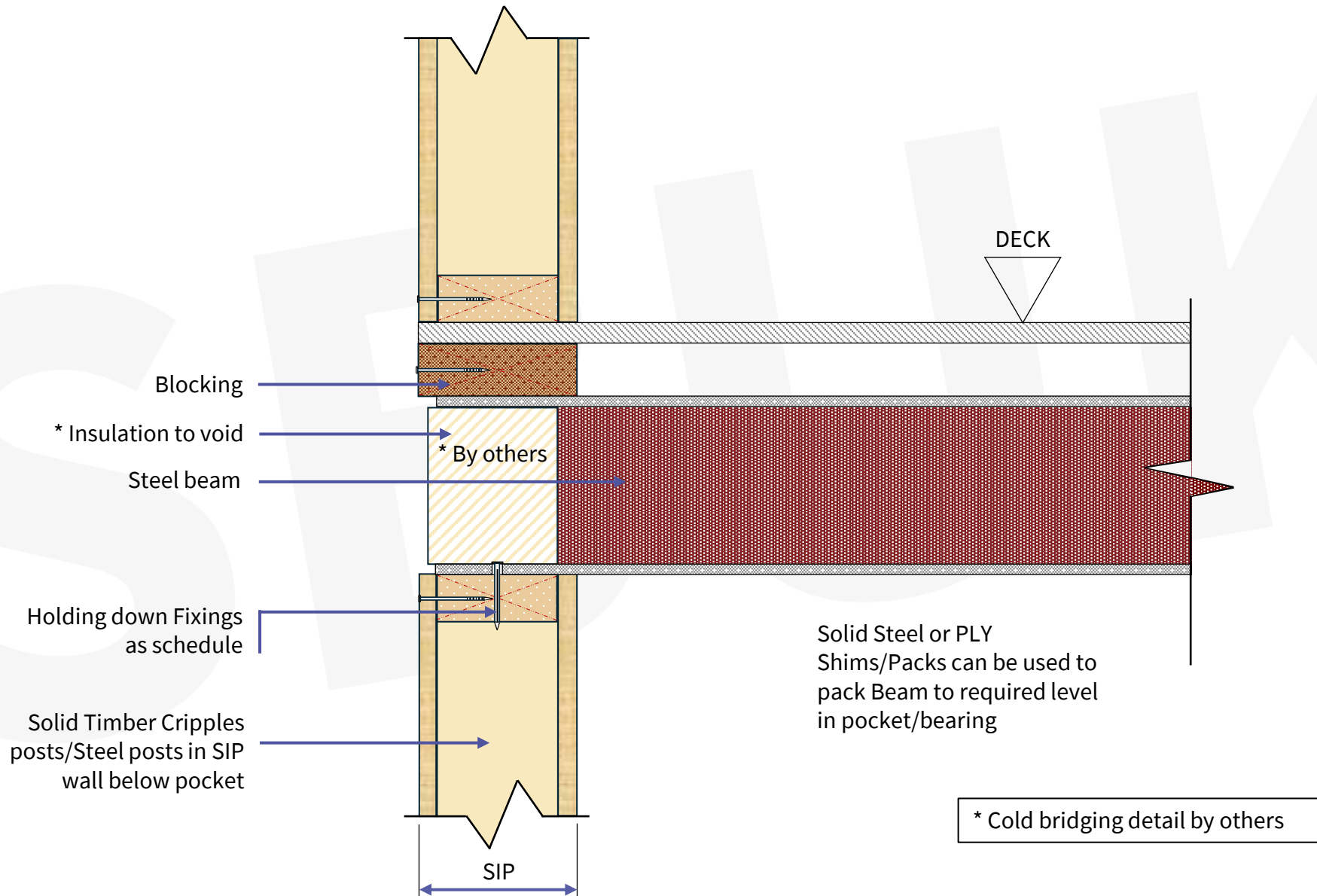

*Details should be considered indicative only. Intellectual Property of SBUK.

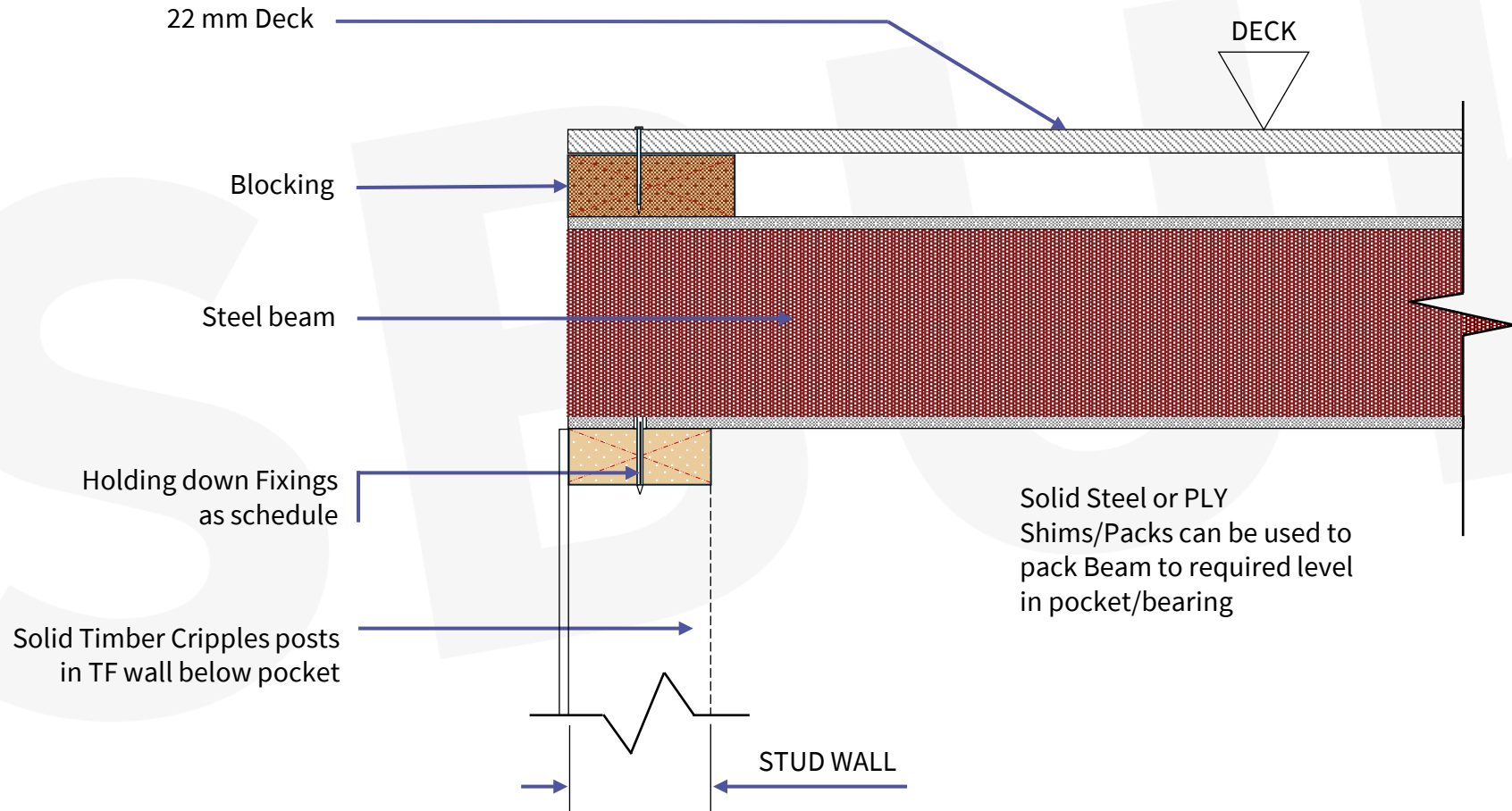

*Details should be considered indicative only. Intellectual Property of SBUK.

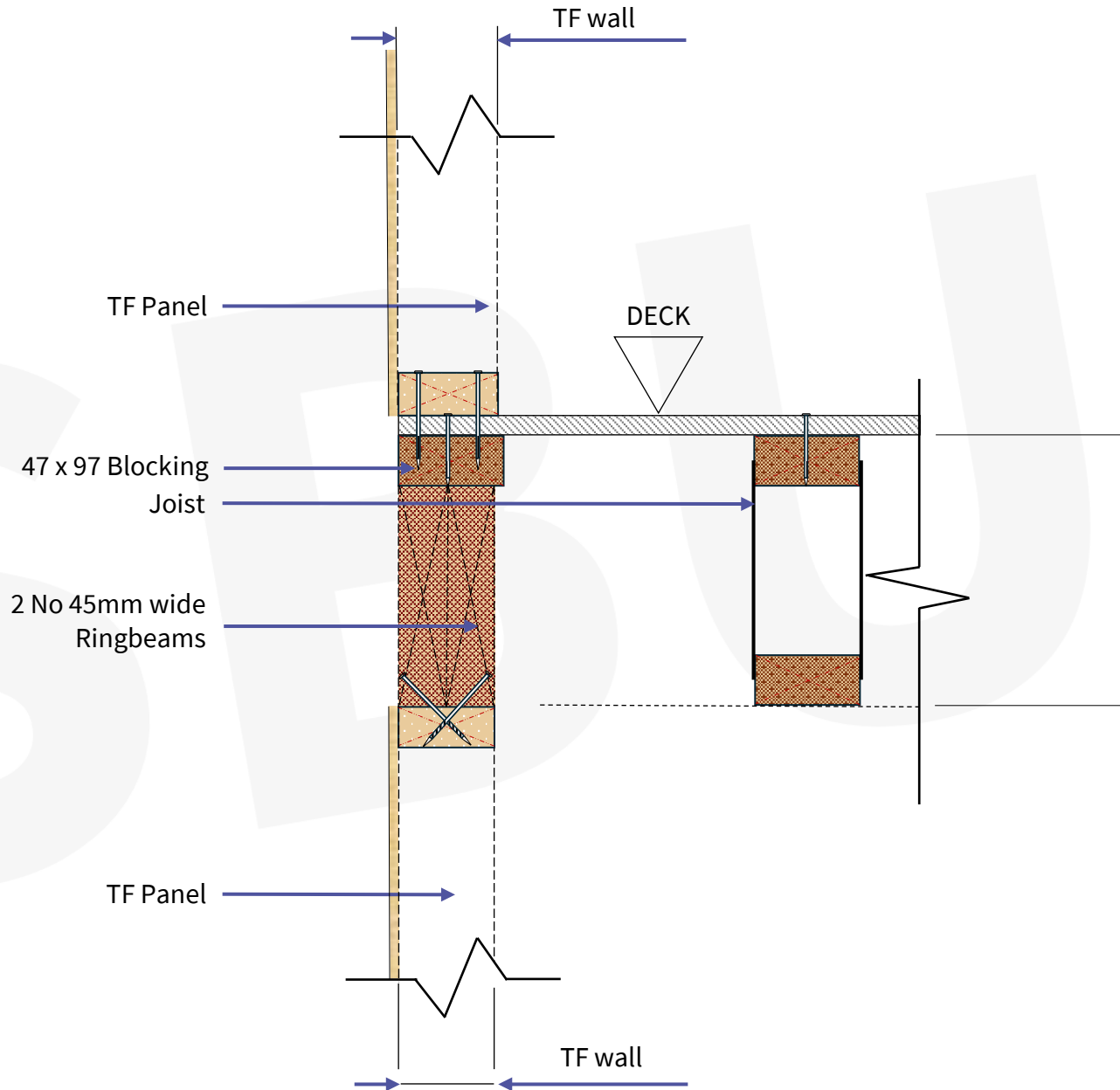

*Details should be considered indicative only. Intellectual Property of SBUK.

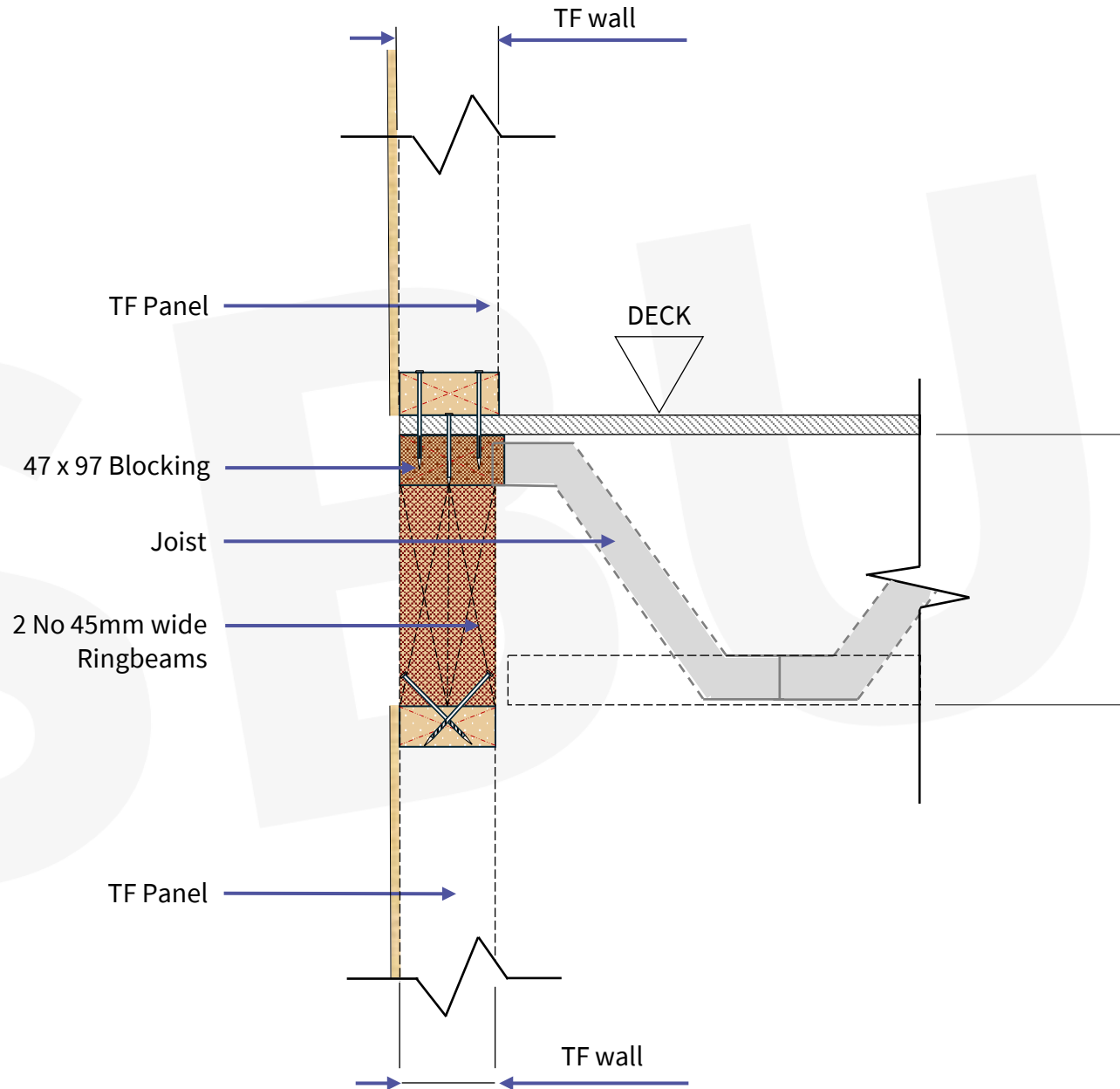

*Details should be considered indicative only. Intellectual Property of SBUK.

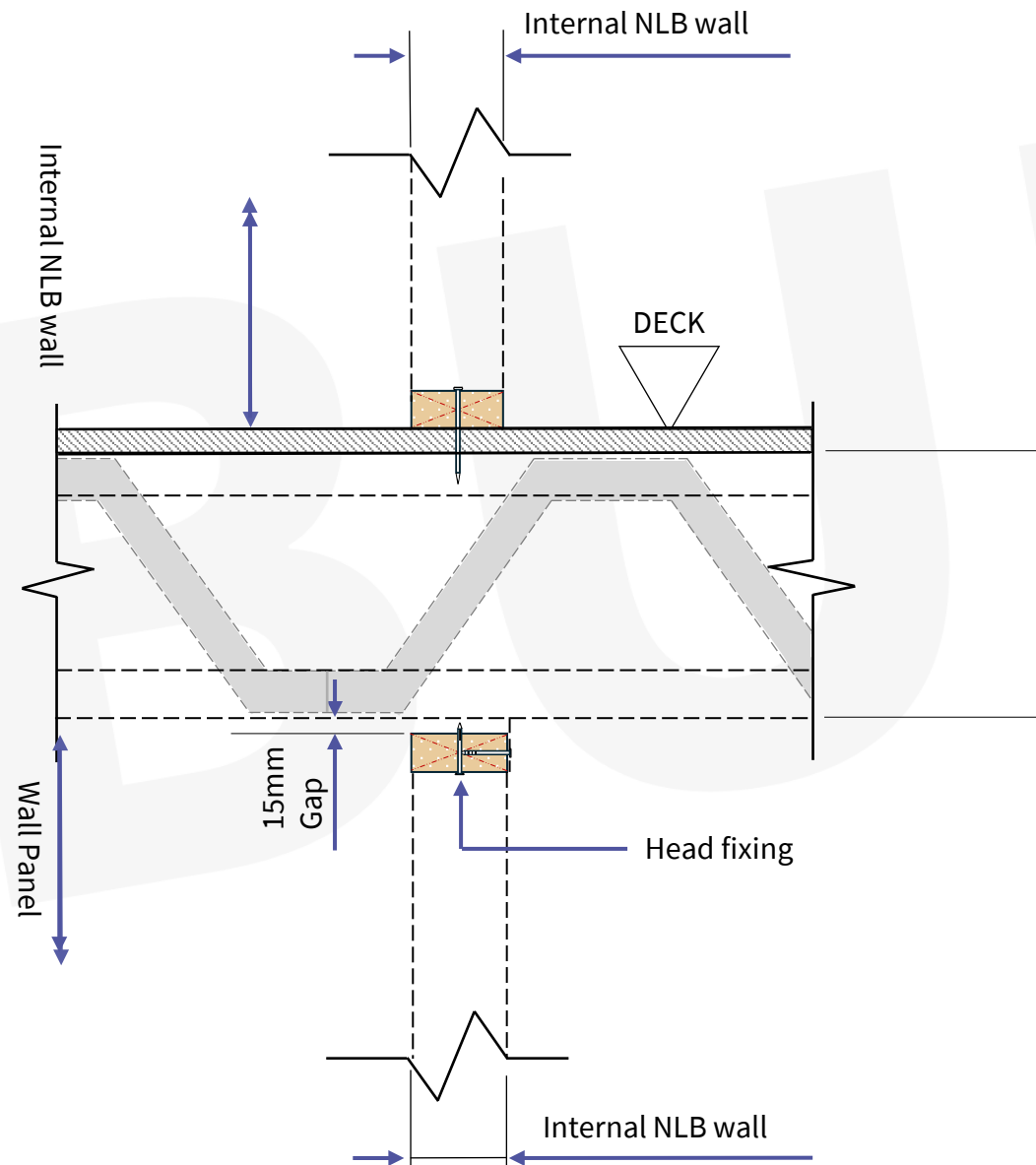

*Details should be considered indicative only. Intellectual Property of SBUK.

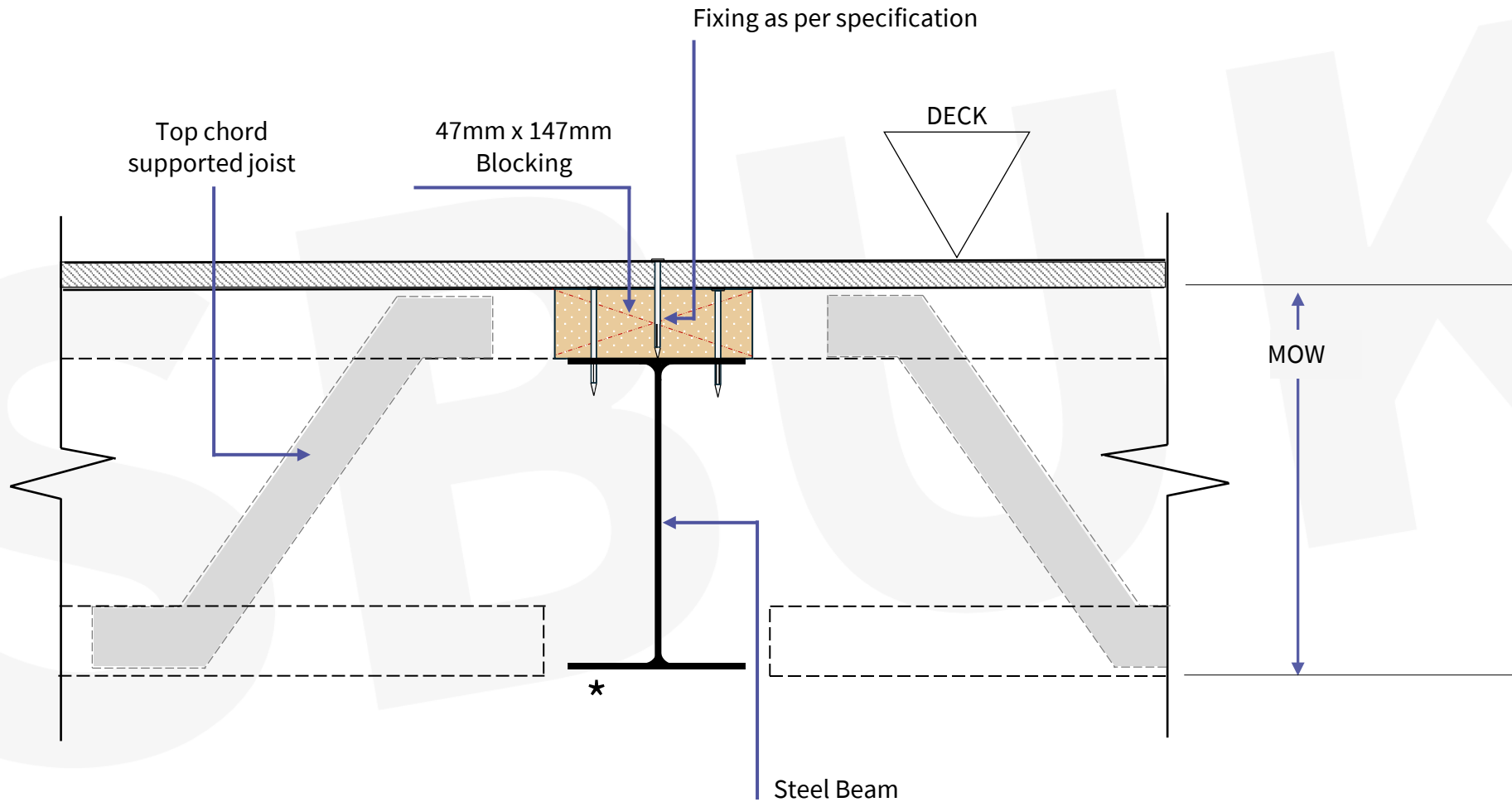

* Potential downstand subject to engineered beam sizes

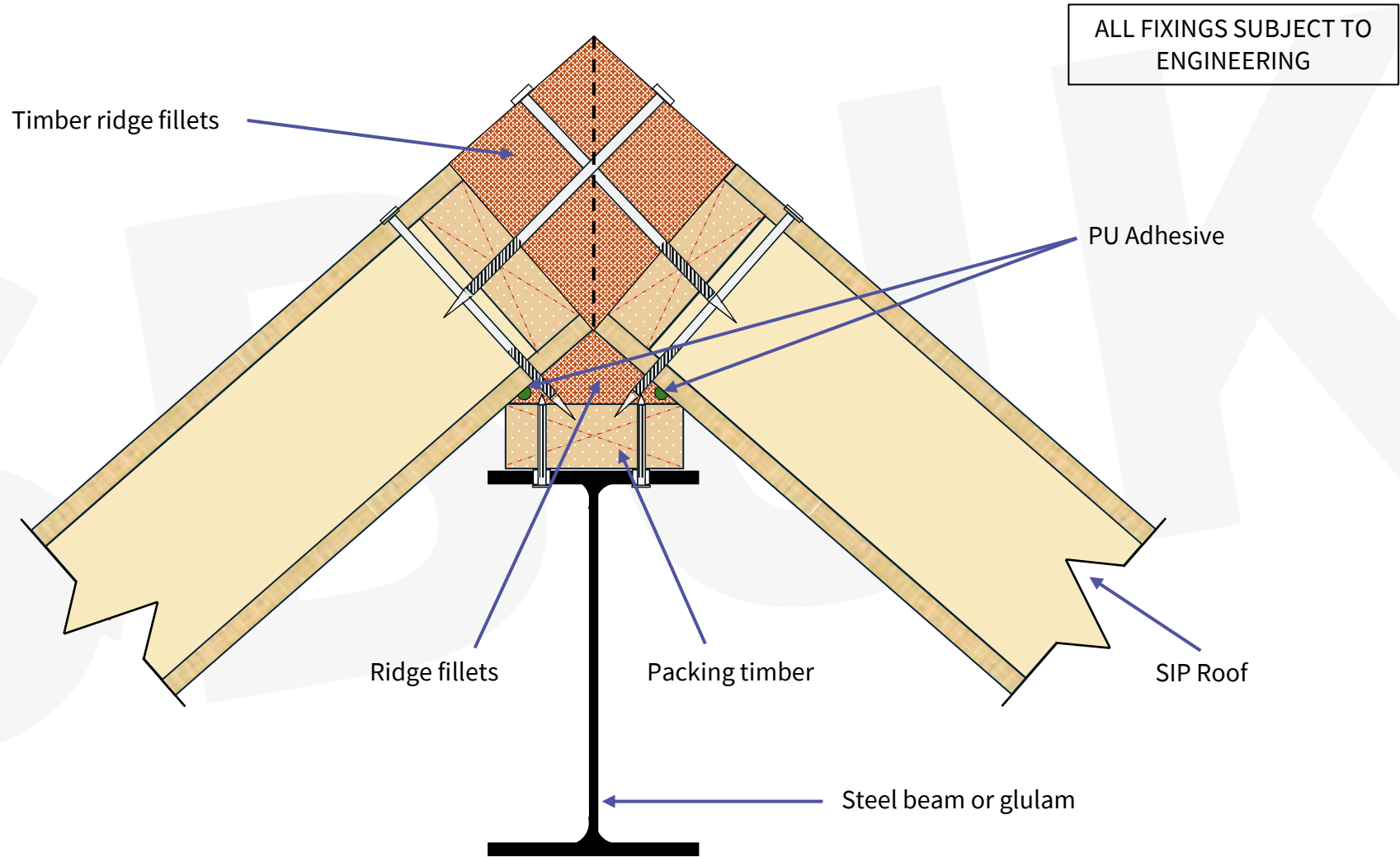

*Details should be considered indicative only. Intellectual Property of SBUK.

ALL FIXINGS SUBJECT TO
ENGINEERING

Rafter extensions
profiled by others
when required

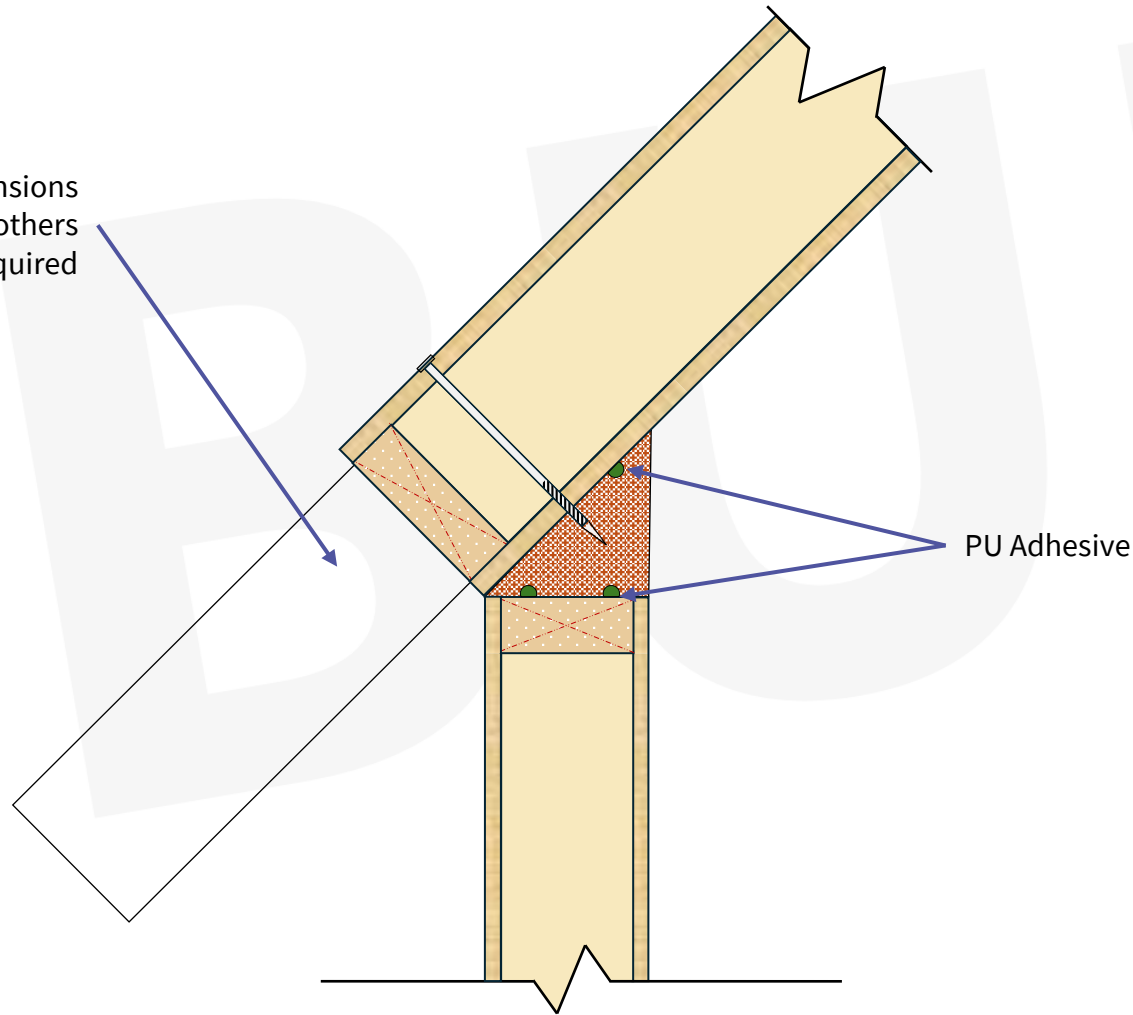

*Details should be considered indicative only. Intellectual Property of SBUK.

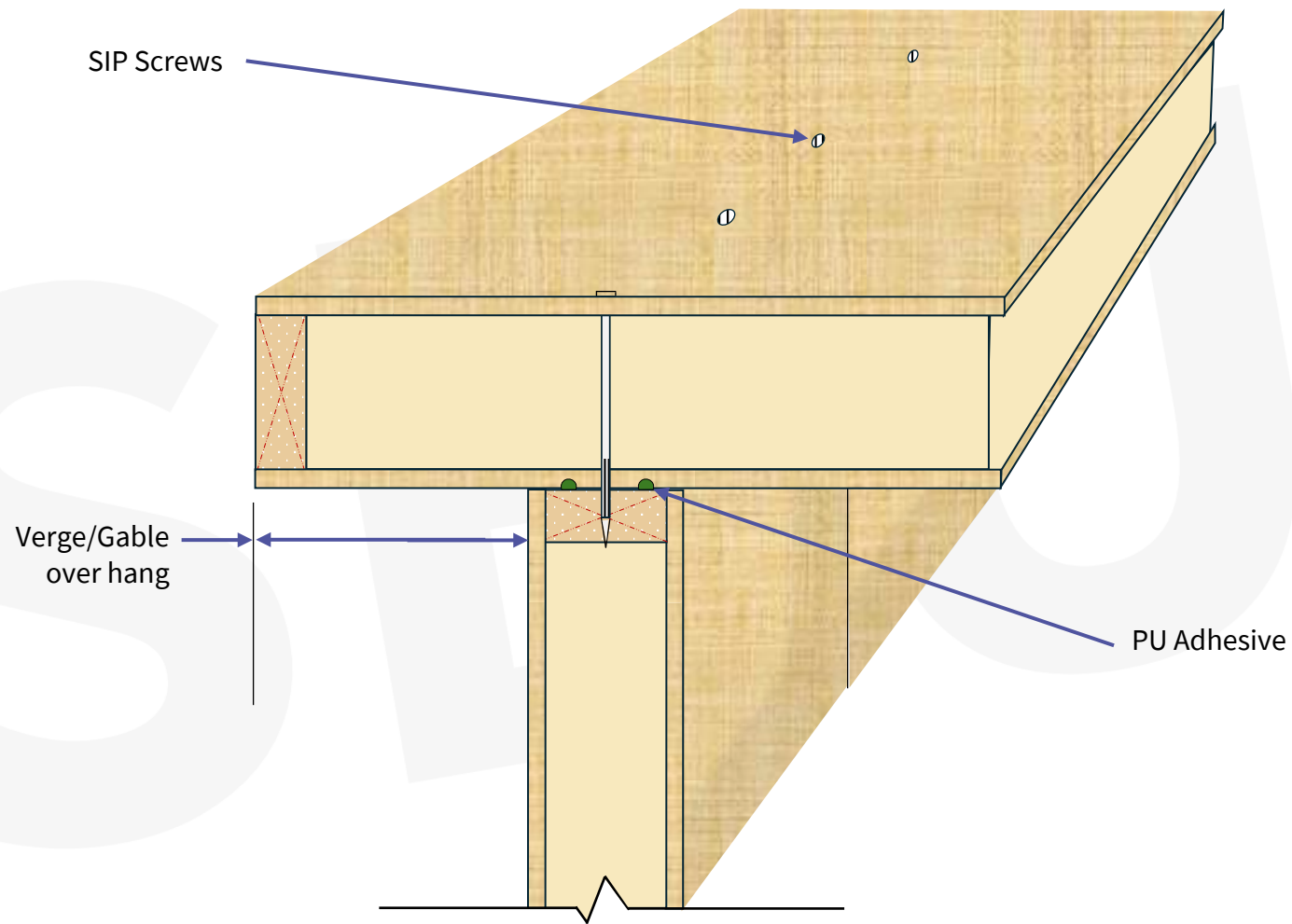

ALL FIXINGS SUBJECT TO
ENGINEERING

*Details should be considered indicative only. Intellectual Property of SBUK.